

Document Scanner DR-2050C/SP Easy Start Guide

Thank you for purchasing the Canon DR-2050C/DR-2050SP Document Scanner. This Easy Start Guide describes the procedure for setting up the scanner for use. Follow the procedures outlined in this Easy Start Guide to set up the scanner. Details on using the scanner are described in the User's Guides packaged with the scanner. Before you use the scanner, make sure to thoroughly read the User's Guides.

STEP 1 Checking the Accessories

When you unpack your scanner, make sure that it contains all of the following accessories. If any of the items listed below are missing or damaged, contact your local authorized Canon dealer or service representative.

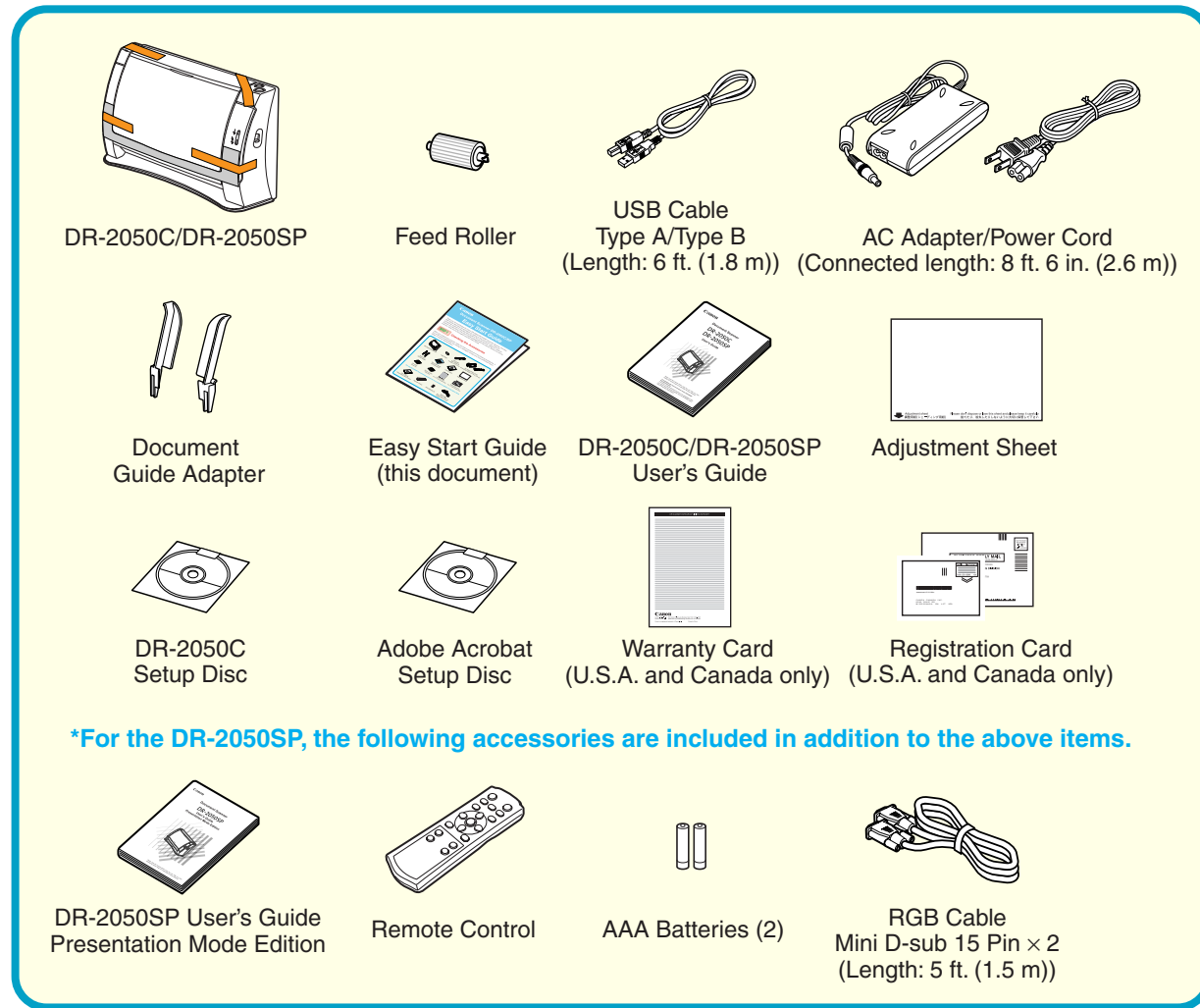

Note

- To use the feed roller, install it on the scanner.
- [STEP 2] "Removing the Packing Materials and Installing the Feed Roller"
- Documents can be prevented from feeding slantwise by installing the document guide adapters on the document guides. ([STEP 5])
- The adjustment sheet is used to adjust the scanner when anomalies begin to appear in scanned images. Store it in a safe place where it will not be lost.
- The DR-2050 Setup Disc contains the "DR-2050C Scanner Driver", "CapturePerfect 3.0", and "OmniPage SE" made by Nuance Communications Inc.
- DR-2050C/DR-2050SP User's Guide p.17 "About the Setup Disc"
- Items included in this package are subject to change without notice.
- You must keep the machine's packaging and packing materials for storing or transporting the machine.

After checking the package contents, you need to prepare the scanner for use. ([STEP 2])

STEP 2 Removing the Packing Materials and Installing the Feed Roller

Remove the scanner from the box, remove the orange tape and protective sheets from the scanner, and install the feed roller on the scanner body.

- Peel off the four pieces of orange tape from the outer casing.

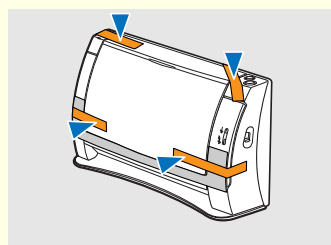

- Open the document feed tray and remove the protective sheet.

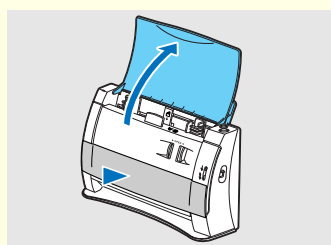

- Open the front cover at (1) and (2), and remove the orange tape fastening the roller cover.

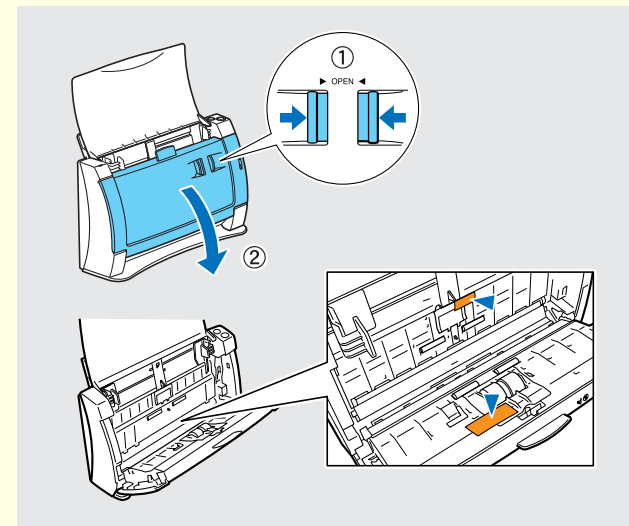

- Open the roller cover.

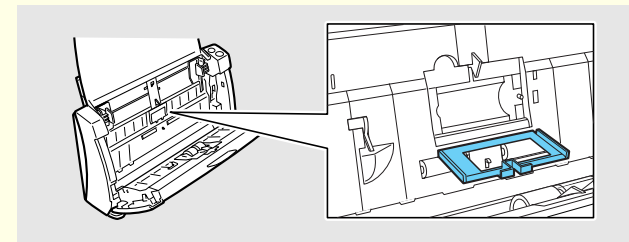

- Lower the roller lock lever (1), and slide it towards the left (2).

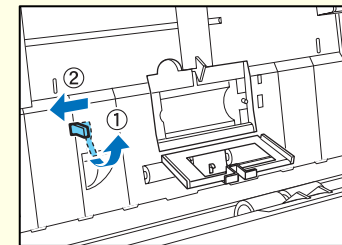

- Load the feed roller, align the notch on the roller with the shaft on the scanner body.

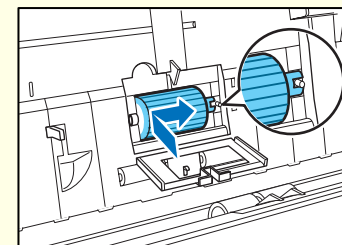

- Slide the roller lock lever towards the right, fit the lever feed roller into the hole on the left of the roller (1), and push down the roller lock lever to lock the feed roller shaft (2).

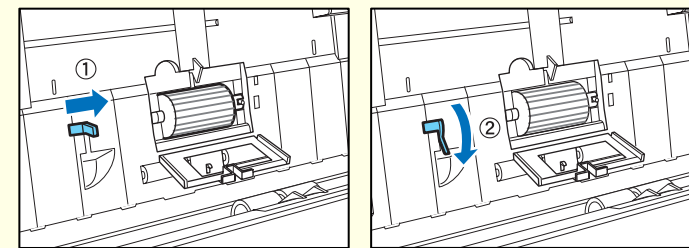

- Close the roller cover. Make sure that the roller cover clicks into place.

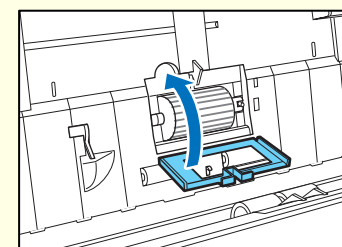

- Gently push in the front unit on its left and right sides to close the front unit. Make sure that the front unit clicks into place.

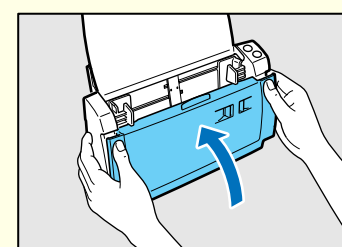

- Close the document feed tray and top cover.

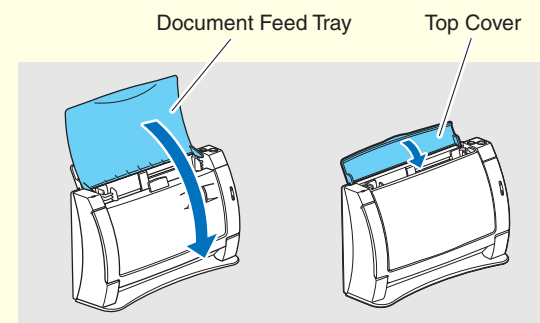

The scanner is now ready for use.
Next, you need to install the scanner software. ([STEP 3])

Trademarks

- Canon and the Canon logo are registered trademarks of Canon Inc. in the United States and may also be trademarks or registered trademarks in other countries.
- Microsoft Windows® is a registered trademark of Microsoft USA in the United States and other countries.
- Other brands and product names used in this manual may be trademarks or registered trademarks of their respective companies.

STEP 3 Installing the Software

Install the software before connecting the scanner to the computer.

Warning

- Before installing the software, make sure your computer is correctly running one of the following versions of Windows. For details, refer to the DR-2050C/DR-2050SP User's Guide.
 - Windows 98SE
 - Windows Me
 - Windows 2000 Professional SP4 or later
 - Windows XP Home Edition SP2 or later
 - Windows XP Professional SP2 or later

- Do not connect the scanner to the computer before installing the software. If you connect the scanner and turn it ON before you install the software, a wizard screen will appear. If this wizard appears, click [Cancel] to exit the wizard, and then turn the scanner OFF.



Wizard Screen (Windows 2000)

- Be sure to log on with administrator privileges when logging on to Windows.
- Close all other applications before installing the software.

- Turn ON your computer.

- Insert the DR-2050C Setup Disc into the PC's CD-ROM drive.
The setup wizard automatically starts up when you insert the CD-ROM into the CD-ROM drive. If the setup wizard does not start up, execute setup.exe in the CD-ROM.

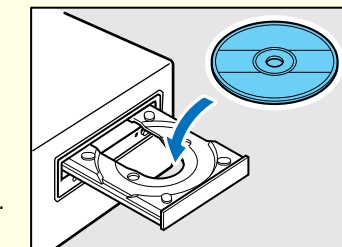

- Click [Typical Installation].

If you click [Typical Installation], all of the software is installed. If you want to select which parts of the software to install, click [Custom Installation].

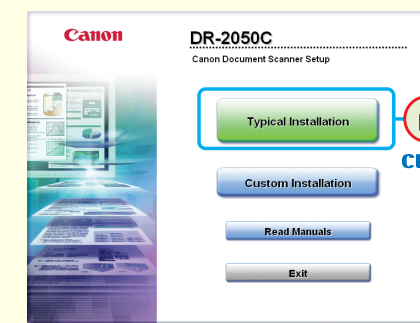

- Click [Install].

All of the currently displayed software is installed. To install only selected software, click [Back] and select [Custom Installation].

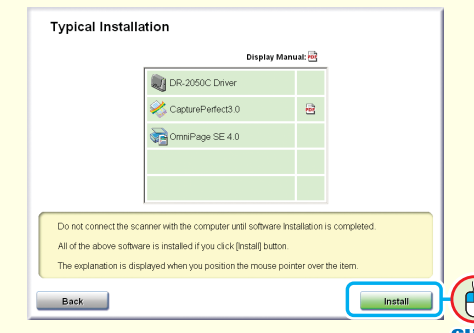

- Click [Next].



- Read the software license agreement, and click [Yes] if you consent to the conditions of the software.

Installation of the scanner driver starts.

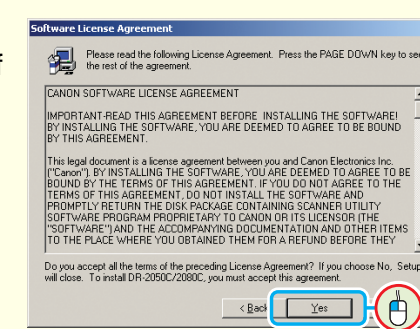

During scanner driver installation, the scanner driver and the Job Registration Tool are installed.

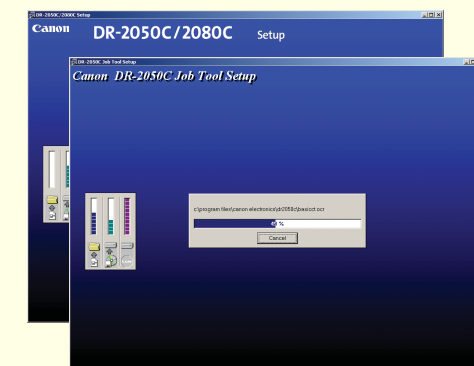

- Click [Finish] to complete the installation. Next, the installation wizard for CapturePerfect 3.0 appears.

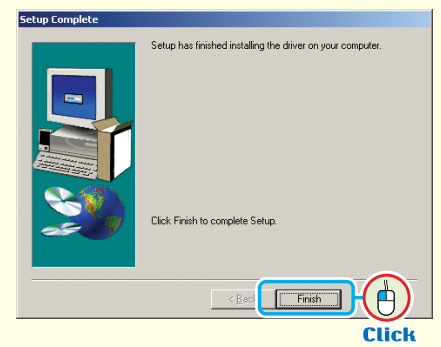

- Click [Next].

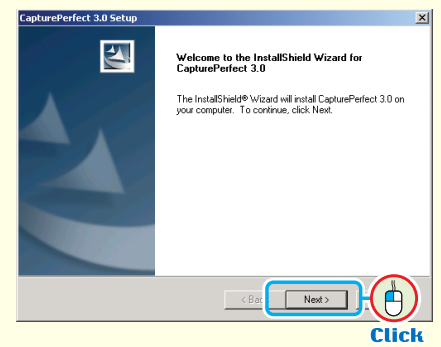

- Read the software license agreement, and click [Yes] if you consent to the conditions of the software.

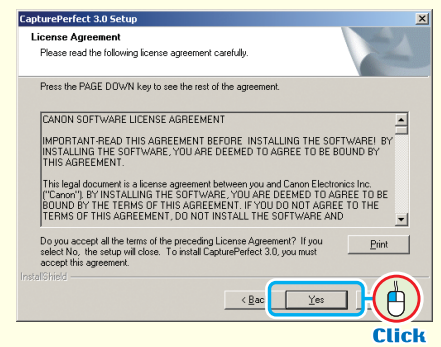

- Check the destination folder and click [Next].

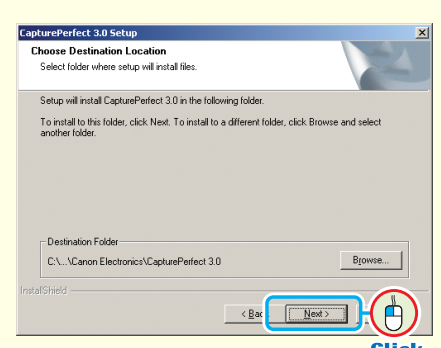

Installation of CapturePerfect 3.0 starts.



- Click [Finish] to complete the installation of CapturePerfect 3.0.

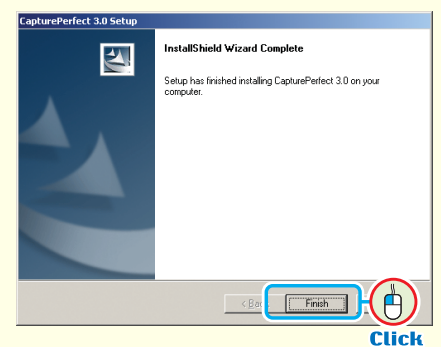

- Next, installation of OmniPage SE starts. Follow the messages on the screen to proceed with the installation.

- When all installations are complete, the Installation completed screen appears. Click [Exit] to exit the installer. (Click [Back] to return to the menu screen.)

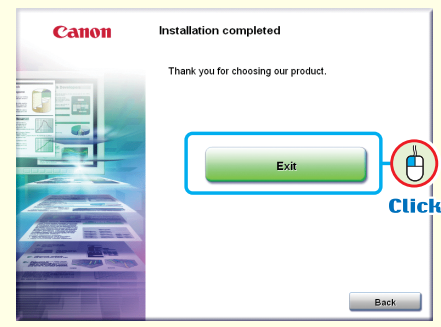

- Remove the setup disc, and finish the software installation.

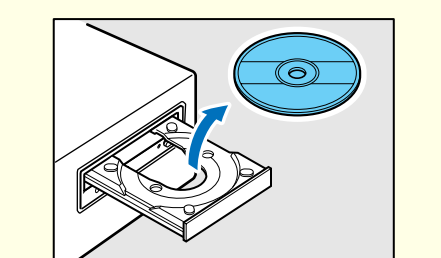

Note

- When software is installed the icons are added to the Program menu.

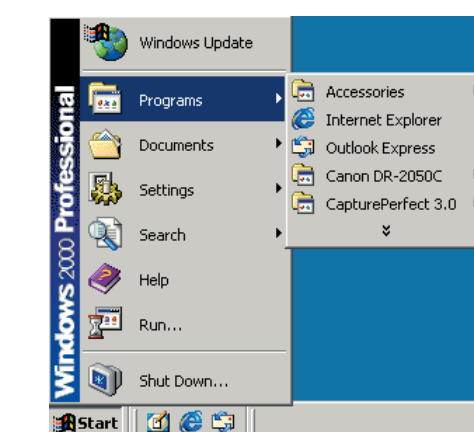

(Windows 2000)

This completes the software installation.
Next, you need to connect the scanner to your computer. ([STEP 4])

STEP 4 Connecting and Registering the Scanner to Your PC

Perform the following steps to connect the scanner, turn it on, and register it to your PC.

Warning

- ❑ Use only the AC adapter included in the package.
- ❑ Connect the DR-2050C to your computer while the DR-2050C is turned OFF.
- ❑ Be sure to log on with administrator privileges when logging on to Windows.

1. Connect the power cord to the AC adapter (①).
2. Plug the AC adapter into the connector located to the left of the connector (②).
3. Plug the power cord into the power outlet (③).
4. Connect the USB cable to the scanner and your PC (④).
5. Check the scanner and computer connections, and press the power button to turn the scanner ON (⑤).

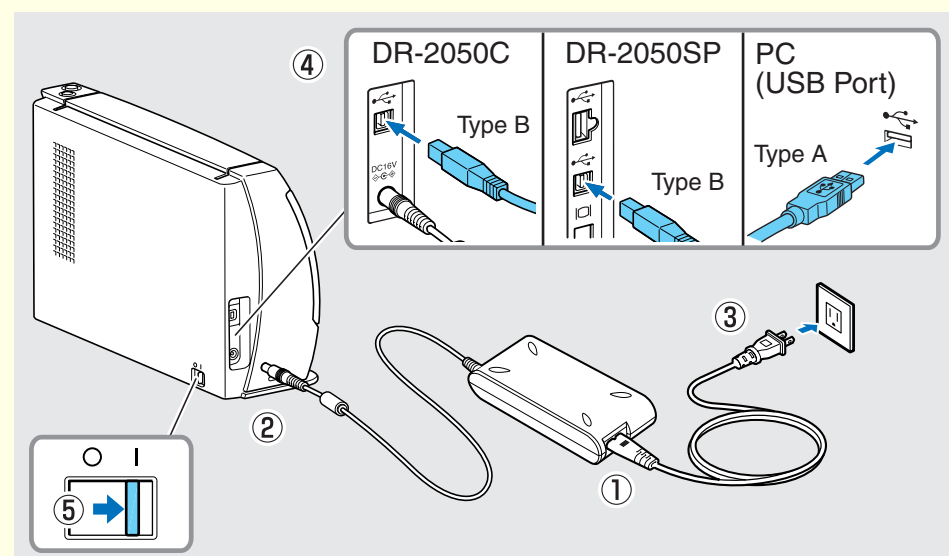

6. Windows recognizes the DR-2050C/SP as the "DR-2050C", and installation is performed automatically.

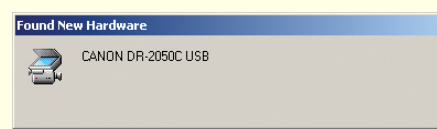

(Windows 98/Me/2000)



(Windows XP)

Note

- For Windows XP, a balloon help pop-up appears when installation is finished.

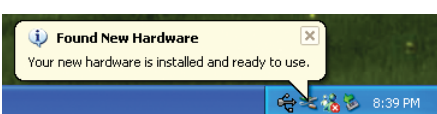

- The installation finished message is not displayed in Windows 98/Me/2000.
- When the DR-2050C/SP is recognized by the PC, it is registered as "CANON DR-2050C USB" in the "Imaging Device" directory of the Device Manager.

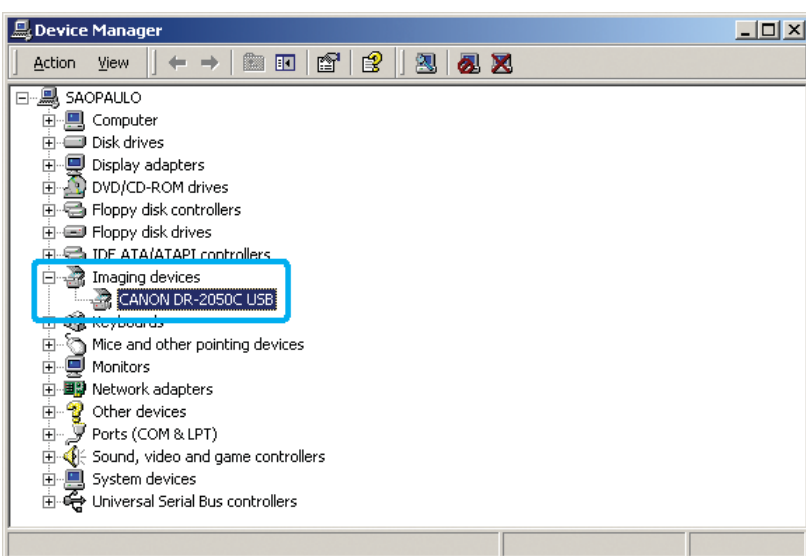

- To open the Device Manager screen, open "System" on the Control Panel and click [Device Manager] on the "Hardware" tab.
- If the OS is Windows XP, "System" is displayed when the display is switched to the classic view display on the Control Panel.

The scanner is now correctly recognized by your computer.
In the last step, you can test that documents are scanned properly.
(STEP 5)

STEP 5 Scanning

When you have finished installing the software and the scanner has been recognized, you can load and scan a document.

With this scanner, scanning can be performed with the job function by simply pressing the scan button. Follow the steps below to load a document, press the scan button, and test that your document is scanned properly.

1. Open the document feed tray.
2. Thoroughly fan the pages of your documents, and shift the pages so that the top edge of the first page is the bottommost page. (Place your documents on the scanner so that the top edge is facing down.)

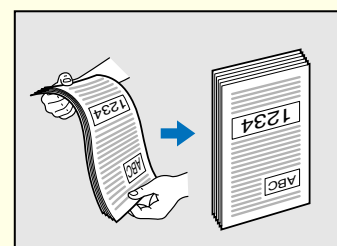

3. Place your documents so that top edge is facing down and the rear side is facing towards you. Adjust the document guide adapter to fit the size of the documents.

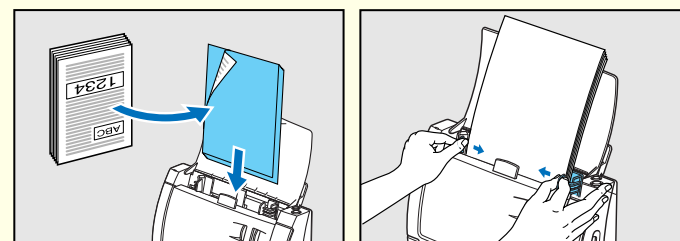

If documents feed slantwise during scanning, attach the document guide adapters to the document guides on both sides of the scanner.

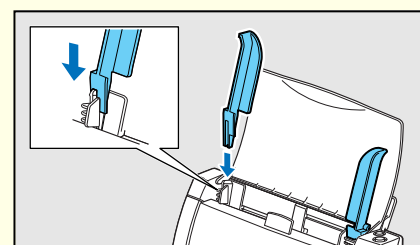

Warning

To move the document guides while the document guide adapters are attached, always grasp the document guides. Grasping the ends of the document guide adapters may cause them to break.

4. Make sure that the feed selection lever on the side is set to the page separation mode (↓). Be careful, because when the feed selection lever is set to ↓ (bypass mode), document pages feed as a stack. For details on the feed selection lever, refer to the DR-2050C/DR-2050SP User's Guide.

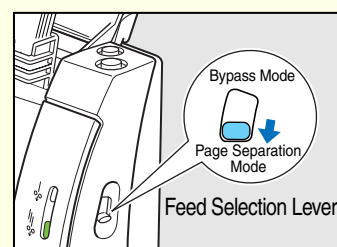

5. Press the Scan button.
"Monitor for DR-2050C" is displayed at the bottom right of the screen and scanning starts.
Scan settings: Black & White, 300 dpi, simplex (default values)

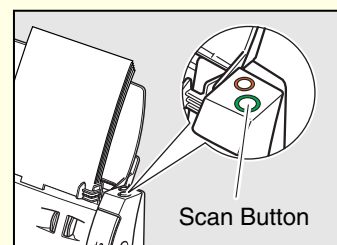

6. When "Sending complete" is displayed on the "Monitor for DR-2050C", this indicates that scanning has ended. Click "Close" to close the "Monitor for DR-2050C".

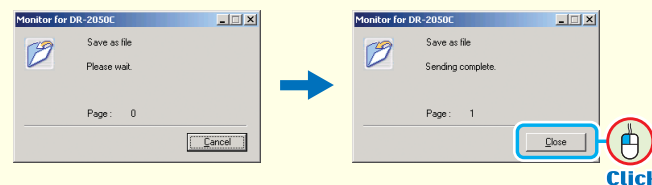

Note

- The function of the job button can be changed.
 - ☛ DR-2050C/DR-2050SP User's Guide p.34 "Using the Job Function" (Default)
- Image files that are saved according to the default settings are saved as PDF files with a 17-digit file name. This file name indicates the date and time that the image was saved.
- You can change the scan settings by using the Job Registration Tool.

The setup is now complete

- This completes setup of the DR-2050C. Details on how to use the DR-2050C are described in the separate DR-2050C/DR-2050SP User's Guide. Before you start using the DR-2050C, be sure to thoroughly read the DR-2050C/DR-2050SP User's Guide.
- When using the DR-2050SP, continue to the next section to test the operation of presentation mode.
- Details on presentation mode are described in the separate DR-2050SP User's Guide Presentation Mode Edition. Before you start using presentation mode, be sure to thoroughly read the DR-2050SP User's Guide Presentation Mode Edition.
- For details on how to use CapturePerfect 3.0, refer to the "CapturePerfect 3.0 Operation Guide" or the online Help included on the CD-ROM.

STEP 6 Preparing Presentation Mode (For the DR-2050SP only)

Perform the following steps to connect the DR-2050SP to an LCD projector (or PC monitor) with the supplied RGB cable (mini D-sub 15 pin).

Warning

- ❑ Always use the supplied RGB cable. The quality of projected images cannot be guaranteed for other RGB cables.

Note

Presentation mode can be tested by connecting the DR-2050SP to a PC monitor. If your projector is in a distant location, such as a conference room, connect the DR-2050 to a PC monitor to check the operation of presentation mode.

1. Disconnect the USB cable connecting the scanner to the PC. Presentation mode cannot be initiated while the scanner and PC are connected. Make sure to disconnect the USB cable connecting the scanner to the PC.
2. Connect the scanner to the LCD projector (or monitor) with the supplied RGB cable.

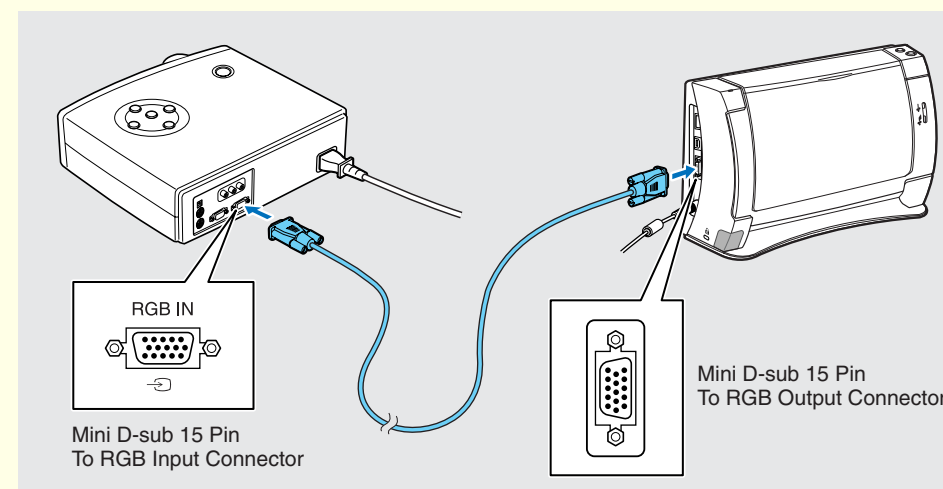

3. Insert the two supplied AAA batteries into the remote control. Align the + and - battery terminals as indicated.

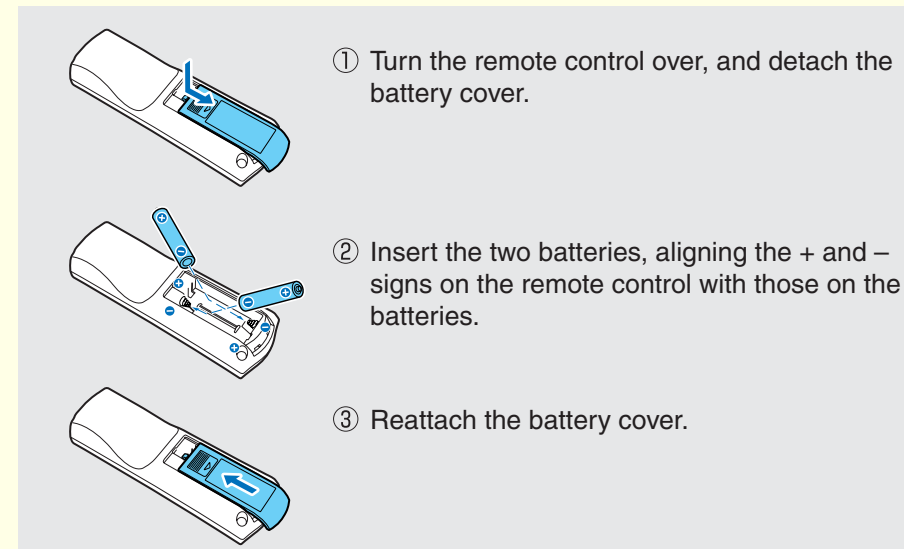

4. Turn on the LCD projector (or monitor).
When connected to an LCD projector, turn on the projector and wait until it warms up and starts projecting.
5. Turn on the scanner.
When the scanner is turned on, the startup screen appears and initialization starts. Wait until the projector is warmed up and projecting before turning on the scanner.

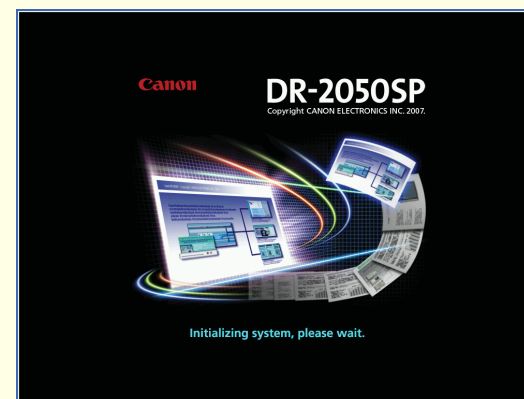

The startup screen is usually displayed for about 20 seconds to 2 minutes. Do not operate the scanner while the startup screen is displayed, because the scanner's internal settings are being initialized.

6. When the startup screen exits, a message appears.

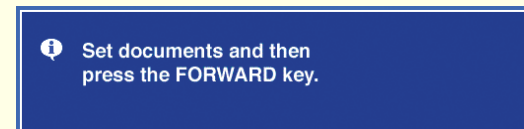

This completes the preparation of presentation mode.
Now you need to scan a document and test that it is projected properly. (STEP 7)

STEP 7 Testing Presentation Mode

Perform the following steps to load and scan a document and confirm that it is projected properly.

1. Load a document in the scanner according to steps 1 to 5 of [STEP 5].

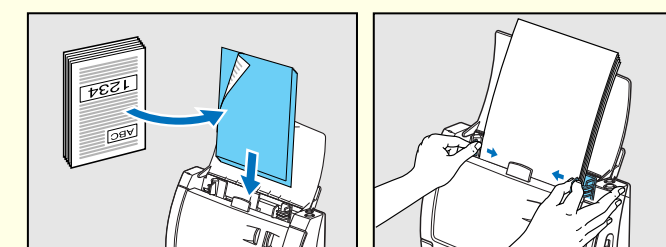

2. Press the scan button on the scanner, or point the remote control at the infrared receiver on the scanner and press the FORWARD key. Scanning starts with the following settings.
Scan settings: Color, 150 dpi, simplex (default values)
When the first page of the document is finished scanning, it is projected. Up to 40 pages can be scanned continuously with simplex scanning.

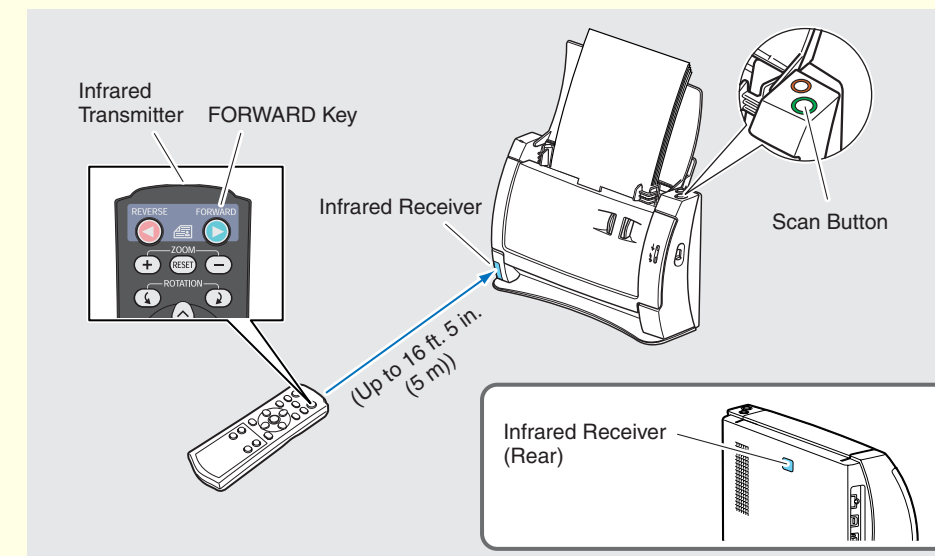

3. Use the remote control to check the scanned image. Use the buttons below to check the displayed image. For details on the functions of other buttons and menu operations, refer to the DR-2050SP User's Guide Presentation Mode Edition.

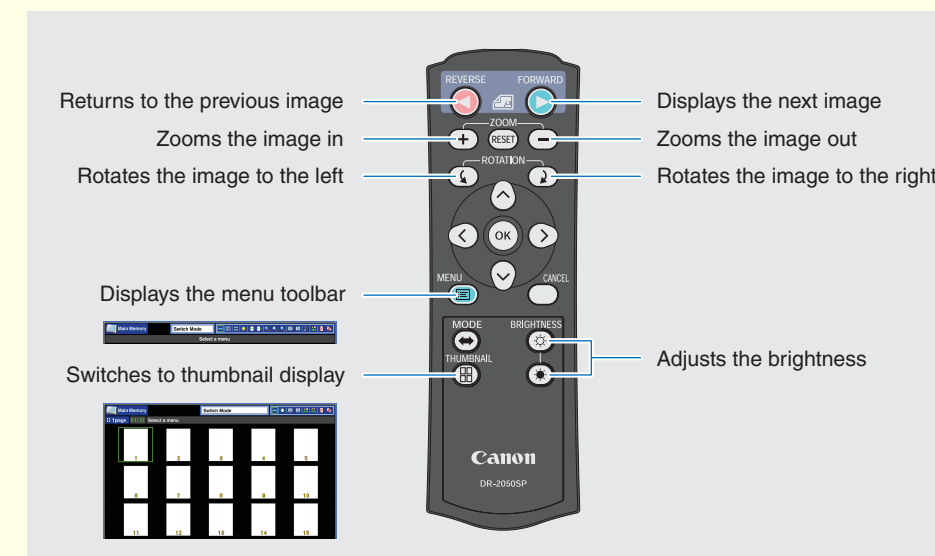

Note

- The scan settings "Color, 150 dpi" are basic specifications for presentation mode, and cannot be changed.
- A maximum of 40 pages of scanned images can be stored in the scanner's memory.
- When scanning is started with no images stored in the scanner's memory, scanning stops when 40 pages have been scanned with simplex scanning (or 20 pages have been scanned with duplex scanning).
- When scanning is started with images already stored in the scanner's memory, scanning stops when a total of 40 pages have been scanned.
- When scanning is started with 40 images already stored in the scanner's memory, only one page is scanned, and the oldest image stored in memory is deleted.

The setup of the DR-2050SP is now complete

- This completes setup of the DR-2050SP. Details on how to use the DR-2050SP are described in the separate DR-2050C/DR-2050SP User's Guide. Before you start using the DR-2050SP, be sure to thoroughly read the DR-2050C/DR-2050SP User's Guide.
- Details on presentation mode are described in the separate DR-2050SP User's Guide Presentation Mode Edition. Before you start using presentation mode, be sure to thoroughly read the DR-2050SP User's Guide Presentation Mode Edition.